

3.278in [83.3mm]  
 2.865in [72.8mm]  
 0.427in [10.8mm]

0.29in [7mm]  
 (MIN INTONATION)

(KNOB KNURLING OMITTED FOR CLARITY)

1.438in [36.5mm]  
 2.250in [57.2mm]

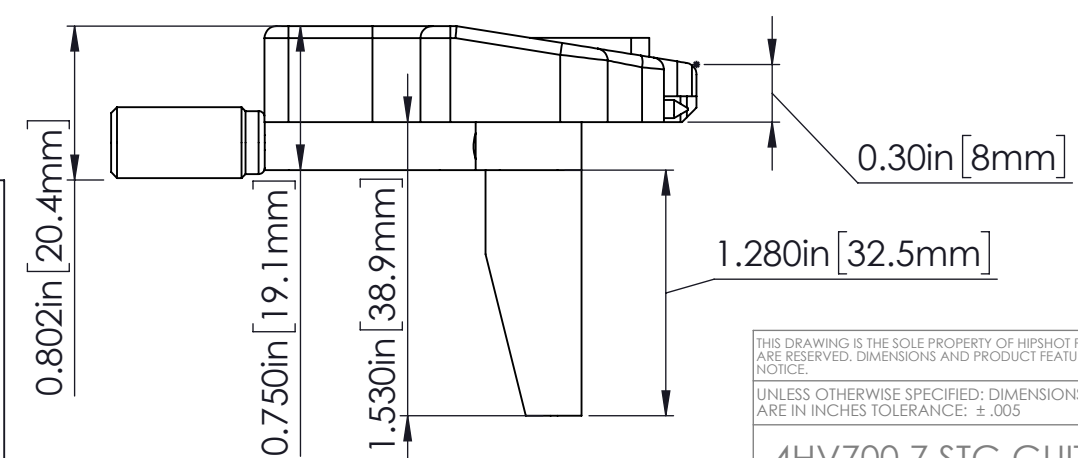
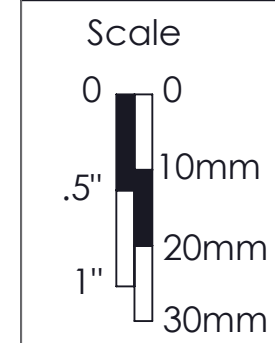

WEIGHT (WITH MOUNTING HARDWARE): 24.3oz [689g]

THIS DRAWING IS THE SOLE PROPERTY OF HIPSHOT PRODUCTS, INC. ALL RIGHTS ARE RESERVED. DIMENSIONS AND PRODUCT FEATURES MAY CHANGE WITHOUT NOTICE.

UNLESS OTHERWISE SPECIFIED; DIMENSIONS ARE IN INCHES TOLERANCE: ± .005

REV DATE: 2/28/2024

**4HV700 7 STG GUITAR  
 HEADLESS TREMOLO BRIDGE**

8248 STATE ROUTE 96  
 Interlaken, NY 14847 U.S.A.  
 TEL: 607-532-9404 FAX: 607-532-9530  
 E-MAIL: info@HipshotProducts.com

BOTTOM VIEW

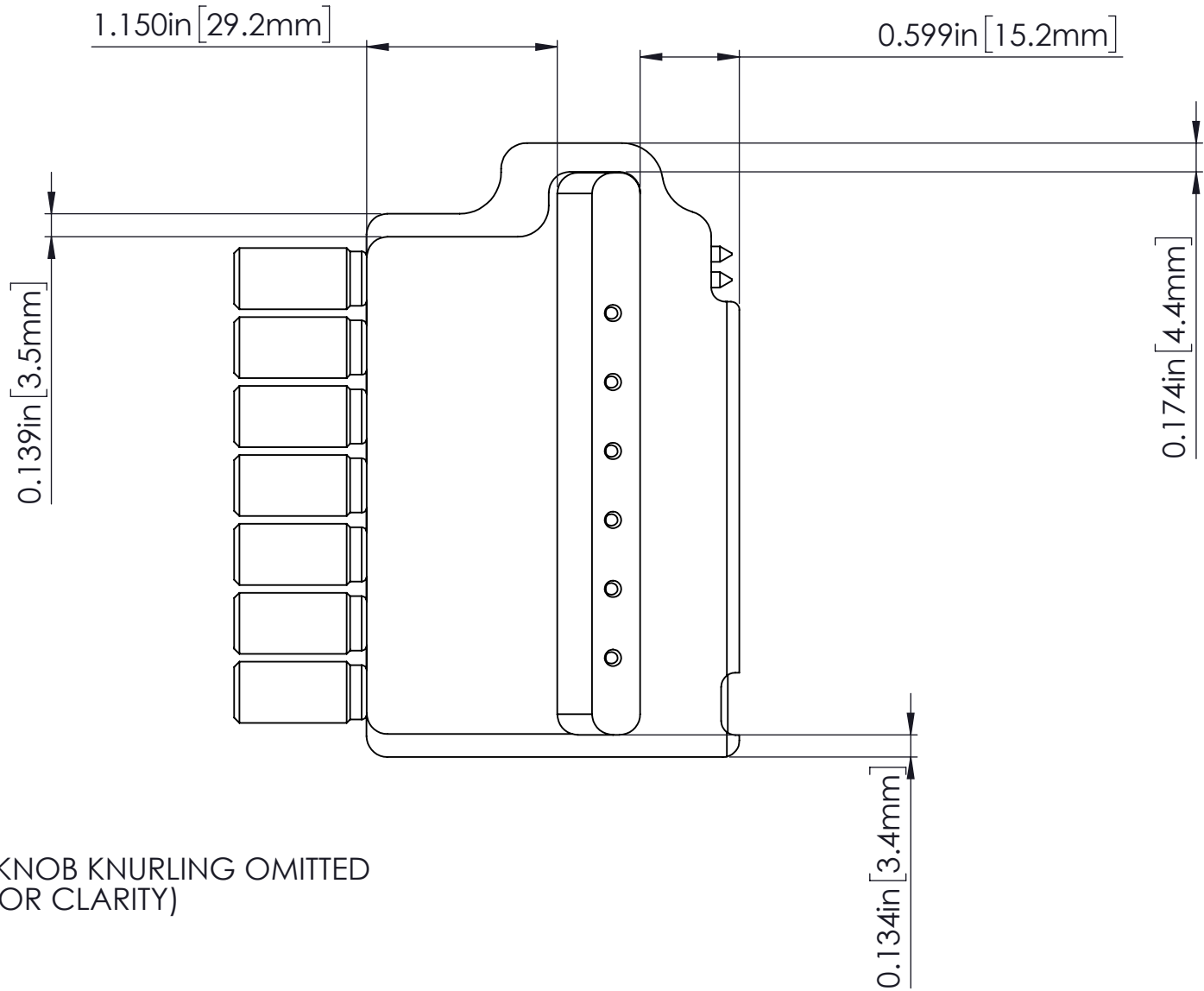

Scale

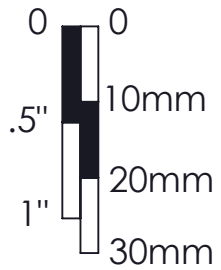

THIS DRAWING IS THE SOLE PROPERTY OF HIPSHOT PRODUCTS, INC. ALL RIGHTS ARE RESERVED. DIMENSIONS AND PRODUCT FEATURES MAY CHANGE WITHOUT NOTICE.

UNLESS OTHERWISE SPECIFIED; DIMENSIONS ARE IN INCHES TOLERANCE:  $\pm .005$

REV DATE: 2/28/2024

4HV700 7 STG GUITAR  
HEADLESS TREMOLO BRIDGE



8248 STATE ROUTE 96  
Interlaken, NY 14847 U.S.A.  
TEL: 607-532-9404 FAX: 607-532-9530  
E-MAIL: info@HipshotProducts.com

TOP ROUTE TEMPLATE

R0.250in [6.4mm]  
(TYPICAL)

2.875in [73.0mm]

STUD HOLES  $\phi$  .375in [9.5mm]

1.600in [40.6mm]

1.318in [33.5mm]

1.318in [33.5mm]

2.000in [50.8mm]

1.600in [40.6mm]

0.219in [5.6mm]

0.490in [12.4mm]

0.875in [22.2mm]

0.271in [6.9mm]

SCALE LINE

MINIMUM CLEARANCE  
FOR TUNING KNOBS  
NOTE: ADDITIONAL MATERIAL  
WILL NEED TO BE REMOVED FOR  
ERGONOMICS AND FUNCTIONALITY

THIS DRAWING IS THE SOLE PROPERTY OF HIPSHOT PRODUCTS, INC. ALL RIGHTS ARE RESERVED. DIMENSIONS AND PRODUCT FEATURES MAY CHANGE WITHOUT NOTICE.

UNLESS OTHERWISE SPECIFIED; DIMENSIONS ARE IN INCHES TOLERANCE:  $\pm .005$

REV DATE:  
2/28/2024

4HV700 7 STG GUITAR  
HEADLESS TREMOLO BRIDGE



8248 STATE ROUTE 96  
Interlaken, NY 14847 U.S.A.  
TEL: 607-532-9404 FAX: 607-532-9530  
E-MAIL: info@HipshotProducts.com

Scale

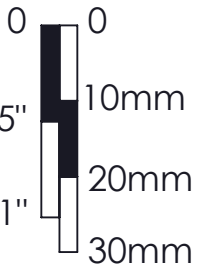

SIDE ROUTE TEMPLATE

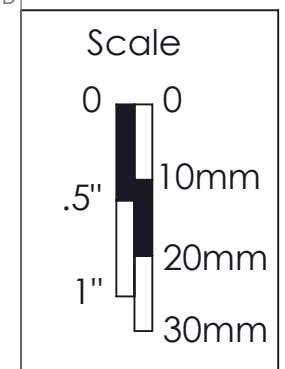
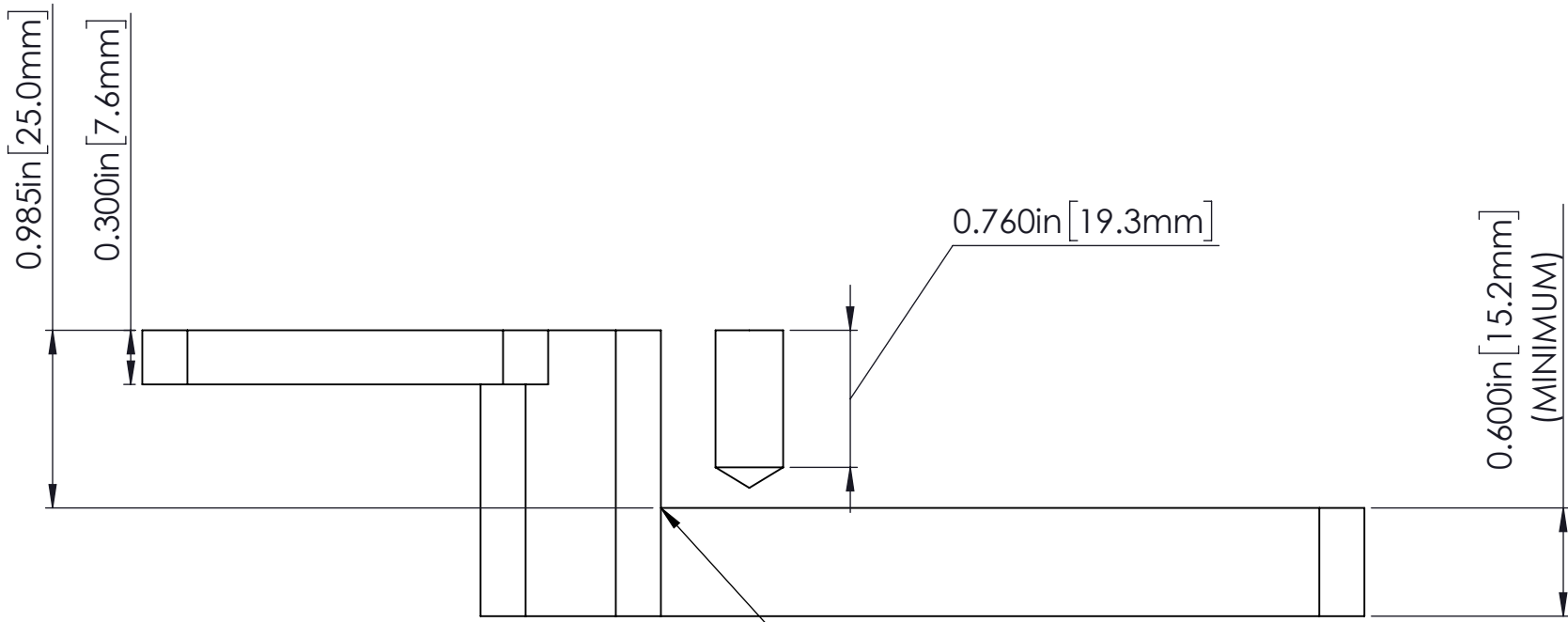

THIS DRAWING IS THE SOLE PROPERTY OF HIPSHOT PRODUCTS, INC. ALL RIGHTS ARE RESERVED. DIMENSIONS AND PRODUCT FEATURES MAY CHANGE WITHOUT NOTICE.

UNLESS OTHERWISE SPECIFIED: DIMENSIONS ARE IN INCHES TOLERANCE:  $\pm .005$

REV DATE: 2/28/2024

4HV700 7 STG GUITAR HEADLESS TREMOLO BRIDGE



8248 STATE ROUTE 96  
 Interlaken, NY 14847 U.S.A.  
 TEL: 607-532-9404 FAX: 607-532-9530  
 E-MAIL: info@HipshotProducts.com

BOTTOM ROUTE TEMPLATE

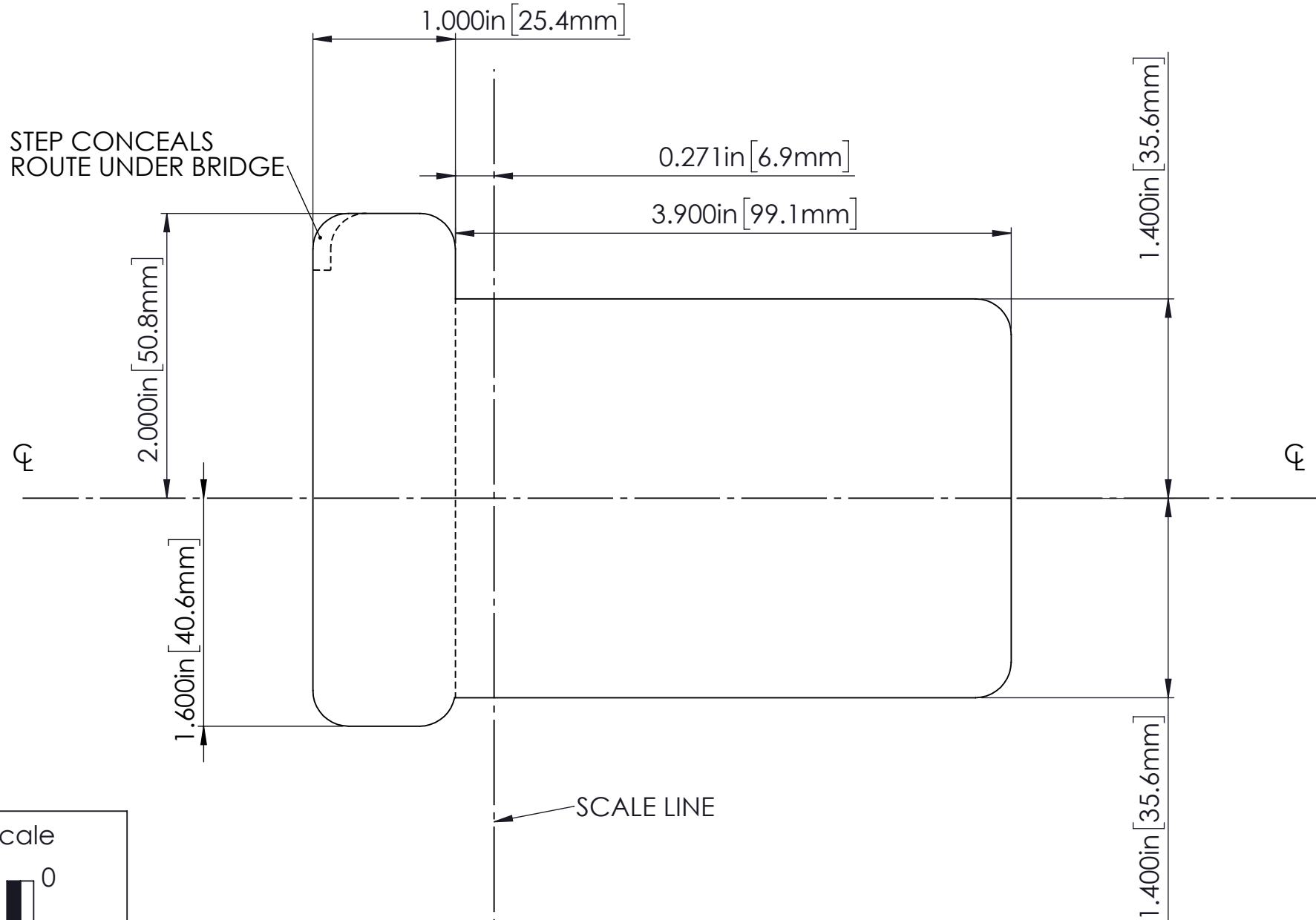

Scale

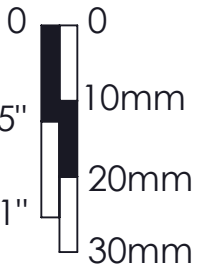

THIS DRAWING IS THE SOLE PROPERTY OF HIPSHOT PRODUCTS, INC. ALL RIGHTS ARE RESERVED. DIMENSIONS AND PRODUCT FEATURES MAY CHANGE WITHOUT NOTICE.

UNLESS OTHERWISE SPECIFIED; DIMENSIONS ARE IN INCHES TOLERANCE:  $\pm .005$

REV DATE: 2/28/2024

4HV700 7 STG GUITAR  
HEADLESS TREMOLO BRIDGE



8248 STATE ROUTE 96  
Interlaken, NY 14847 U.S.A.  
TEL: 607-532-9404 FAX: 607-532-9530  
E-MAIL: info@HipshotProducts.com