

0.82in [21mm]
(MAX INTONATION)

0.47in [12mm]
(MIN INTONATION)

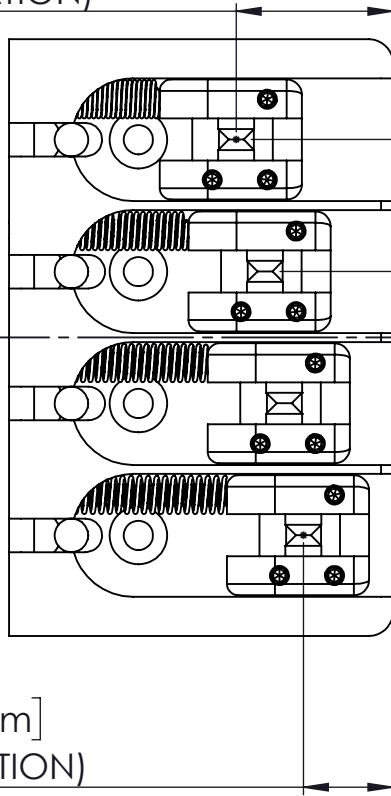

0.687in [17.4mm]
±.062in [1.5mm]
(STRING SPACING)

0.63in [16mm]
(MAX STRING HEIGHT)

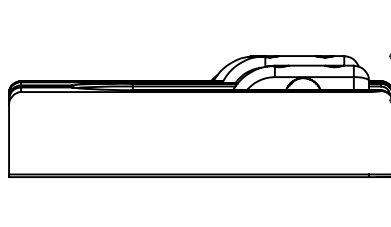

0.40in [10mm]
(MIN STRING HEIGHT)

QUICK RELEASE CHANNELS

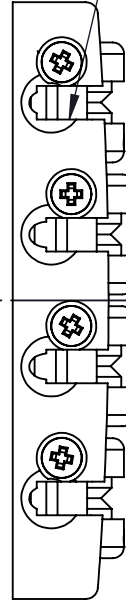

3.108in [78.9mm]

1.675in [42.5mm]
1.326in [33.7mm]

2.000in [50.8mm]

R0.125in [3.2mm]

1.031in [26.2mm]
0.344in [8.7mm]
1.031in [26.2mm]
0.344in [8.7mm]

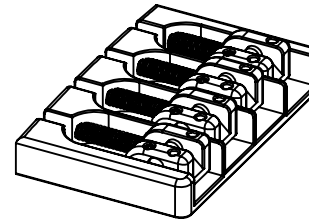

Scale

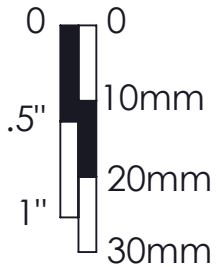

WEIGHT (WITH MOUNTING HARDWARE):
ALUM: 4.4oz [125g] **BRASS:** 8.2oz [232g]

THIS DRAWING IS THE SOLE PROPERTY OF HIPSHOT PRODUCTS, INC. ALL RIGHTS ARE RESERVED. DIMENSIONS AND PRODUCT FEATURES MAY CHANGE WITHOUT NOTICE.

UNLESS OTHERWISE SPECIFIED: DIMENSIONS ARE IN INCHES TOLERANCE: ± .005

REV DATE:
4/10/2021

5A400-687 4 STG A STYLE
BASS BRIDGE .687 SPACING
DIMENSIONS



8248 STATE ROUTE 96
Interlaken, NY 14847 U.S.A.
TEL: 607-532-9404 FAX: 607-532-9530
E-MAIL: info@hipshotproducts.com